

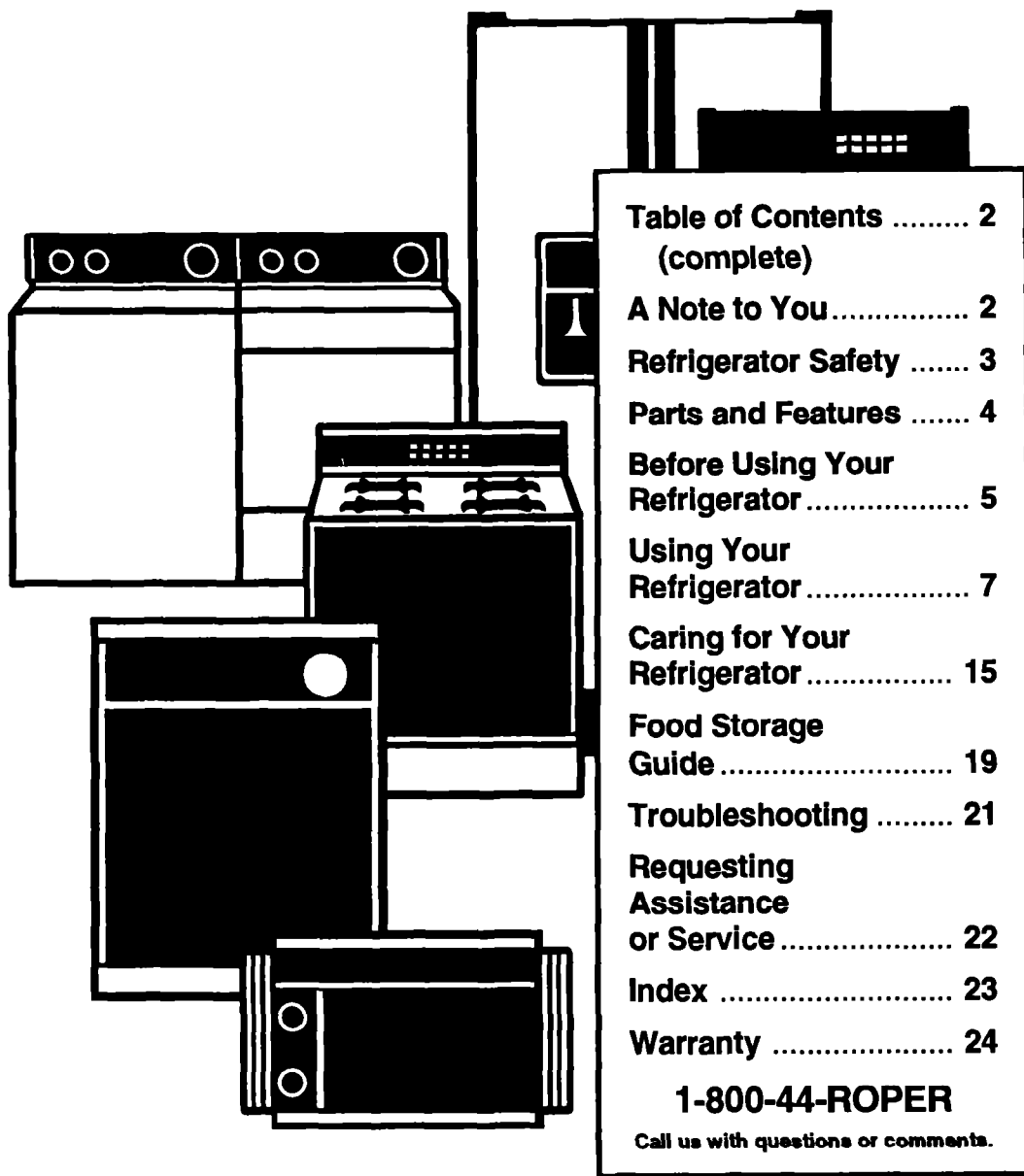

Use And Care

GUIDE



NO-FROST REFRIGERATOR-FREEZER

Part no. 218504800/4343263

MODELS RT18DK RT18EK

1/95

Table of Contents

A Note to You	2	Using the optional automatic ice maker	10
Refrigerator Safety	3	Changing the light bulb	11
Parts and Features	4	Understanding the sounds you may hear	12
Before Using Your Refrigerator	5	Saving energy	12
Cleaning your refrigerator	5	Reversing the door swing	13
Plugging it in	5	Caring for Your Refrigerator	15
Installing it properly	6	Cleaning your refrigerator	15
Leveling it	6	Vacation and moving care	17
Using Your Refrigerator	7	Power interruptions	18
Setting the controls	7	Food Storage Guide	19
Changing the control settings	8	Storing fresh food	19
Adjusting the refrigerator shelves	8	Storing frozen food	20
Removing the meat drawer and cover	9	Troubleshooting	21
Removing the crispers and crisper cover	9	Requesting Assistance or Service	22
Using the ice cube trays	10	Index	23
		Warranty	24

A Note to You

Thank you for buying a Roper® appliance.

Roper appliances give you all the functionality of name brand appliances at a value price. To ensure you enjoy years of trouble-free operation, we developed this Use and Care Guide. It contains valuable information about how to operate and maintain your appliance properly and safely. Please read it carefully. Also, please complete and mail the Ownership Registration Card provided with your appliance. This card helps us notify you about any new information on your appliance.

Please record your model's information.

Whenever you call to request service on your appliance, you need to know your complete model number and serial number. You can find this information on the model and serial number label (see diagrams on page 4 for location of label).

Please also record the purchase date of your appliance and your dealer's name, address, and telephone number.

Model Number _____

Serial Number _____

Purchase Date _____

Dealer Name _____

Dealer Address _____

Dealer Phone _____

Keep this book and the sales slip together in a safe place for future reference.

CALL 1-800-447-6737
WITH QUESTIONS OR COMMENTS

Refrigerator Safety

Your safety is important to us.

This guide contains statements under warning symbols. Please pay special attention to these symbols and follow any instructions given. Here is a brief explanation of the use of the symbol.

WARNING

This symbol alerts you to such dangers as personal injury, burns, fire, and electrical shock.

IMPORTANT SAFETY INSTRUCTIONS

WARNING

To reduce the risk of fire, electrical shock, or injury when using your refrigerator, follow these basic precautions:

- Read all instructions before using the refrigerator.
 - Child entrapment and suffocation are not problems of the past. Junked or abandoned refrigerators are still dangerous ... even if they will "just sit in the garage a few days."
If you are getting rid of your old refrigerator, do it safely. Please read the enclosed safety booklet from the Association of Home Appliance Manufacturers. Help prevent accidents.
 - Never allow children to operate, play with, or crawl inside the refrigerator.
 - Never clean refrigerator parts with flammable fluids. The fumes can create a fire hazard or explosion.
 - FOR YOUR SAFETY •
- DO NOT STORE OR USE GASOLINE OR OTHER FLAMMABLE VAPORS AND LIQUIDS IN THE VICINITY OF THIS OR ANY OTHER APPLIANCE. THE FUMES CAN CREATE A FIRE HAZARD OR EXPLOSION.

– SAVE THESE INSTRUCTIONS –

Help us help you

Please:

- Install and level the refrigerator on a floor that will hold the weight and in an area suitable for its size and use.
- Do not install the refrigerator near an oven, radiator, or other heat source.
- Do not use the refrigerator in an area where the room temperature will fall below 55°F (13°C).
- Keep the refrigerator out of the weather.
- Connect the refrigerator only to the proper kind of outlet, with the correct electrical supply and grounding. (Refer to the Electrical Requirements and Grounding Instructions Sheet.)
- Do not load the refrigerator with food before it has time to get properly cold.
- Use the refrigerator only for the uses described in this manual.
- Properly maintain the refrigerator.
- Be sure the refrigerator is not used by anyone unable to operate it properly.

Parts and Features

Below are illustrations of your appliance with the parts and features called out. To help you find information on specific parts or features faster, page references are included.

Model RT18DK

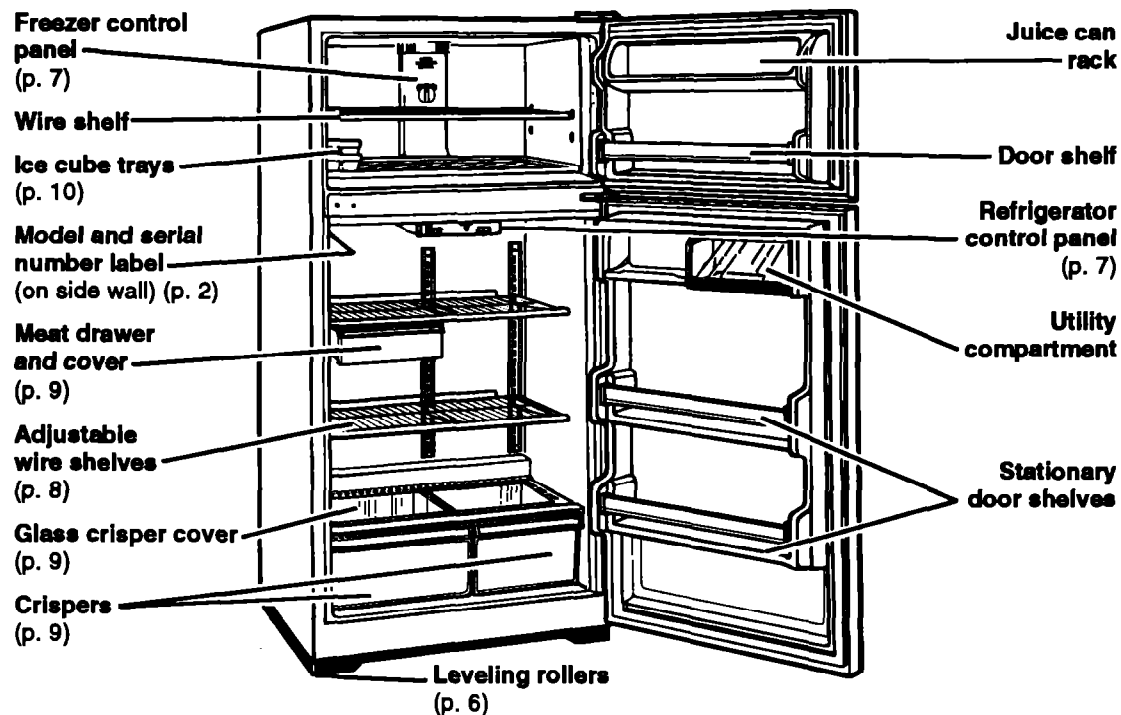

Model RT18EK



Before Using Your Refrigerator

It is important to prepare your refrigerator for use. This section tells you how to clean it, connect it to a power source, install it, and level it.

Cleaning your refrigerator

Removing packaging materials

Remove tape and any inside labels (except the model and serial number label) before using the refrigerator.

To remove any remaining glue:

- Rub briskly with thumb to make a ball, then remove.

OR

- Soak area with liquid hand-dishwashing detergent before removing glue as described above. Do not use sharp instruments, rubbing alcohol, flammable fluids, or abrasive cleaners. These can damage the material. See "Important Safety Instructions" on page 3.

NOTE: Do not remove any permanent instruction labels inside your refrigerator. Do not remove the Tech Sheet fastened under the refrigerator at the front.

Cleaning it before use



After removing all packaging materials, clean your refrigerator before using it, if necessary. See cleaning instructions on pages 15-16.

Plugging it in

Recommended Grounding Method

A 115 Volt, 60 Hz., AC only 15 or 20 ampere fused and properly grounded electrical supply is required. It is recommended that a separate circuit serving only this appliance be provided. Use a receptacle which cannot be turned off with a switch or pull chain. Do not use an extension cord.

See Electrical Requirements and Grounding Instructions Sheet in your Literature Package.

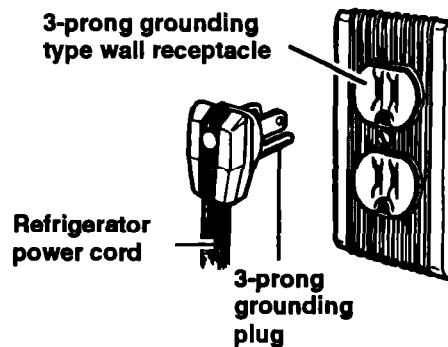

BEFORE USING YOUR REFRIGERATOR

Installing it properly

1. Allow ½ inch (1.25 cm) air space on each side of the refrigerator for ease of installation.
2. Allow 1 inch (2.5 cm) air space behind and 3 inches (7.5 cm) air space above the refrigerator for proper circulation.
3. If installing the refrigerator with the hinge side against a wall, you might want to leave extra space so the door can be opened wider.
4. Make sure the floor below the refrigerator is level and strong enough to support a fully-loaded refrigerator.

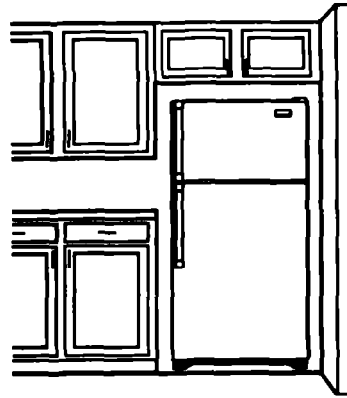

Leveling it

Model RT18DK

Your refrigerator has 2 front leveling screws – one on the right and one on the left. To adjust one or both of these, follow the directions below.

1. Open refrigerator door.
2. To raise front, turn screw clockwise.
3. To lower front, turn screw counterclockwise.
4. Check with level.
5. Close refrigerator door.

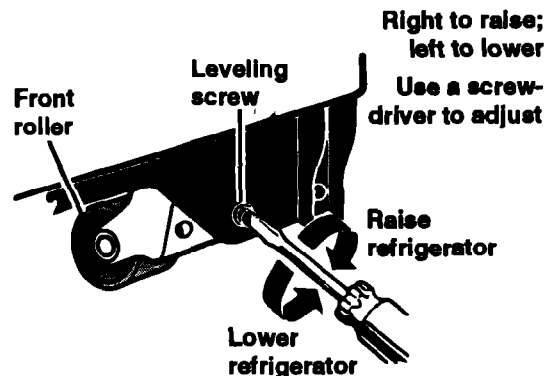

Model RT18EK

Your refrigerator has 2 front leveling legs – one on the right and one on the left. To adjust one or both of these, follow the directions below.

1. Open the refrigerator door.
2. Tilt refrigerator back slightly.
3. Turn leveling leg to adjust height.
4. Replace refrigerator on floor.
5. Check with level.
6. Close refrigerator door.

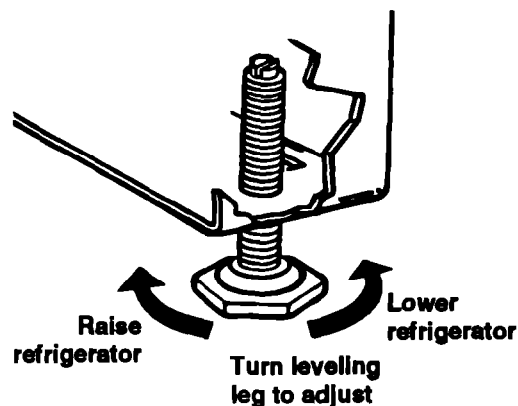

Using Your Refrigerator

To obtain the best possible results from your refrigerator, it is important that you operate it properly. This sections tells you how to set the controls, remove and adjust some of the features in your refrigerator, how to save energy, and how to reverse the door swing.

Setting the controls

Refrigerator control

The Refrigerator Control is in the refrigerator. When you plug in the refrigerator for the first time:

- Set the Refrigerator Control to 0 (mid setting).

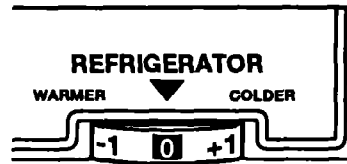

Freezer control

The Freezer Control is in the freezer. When you plug in the refrigerator for the first time:

- Set the Freezer Control halfway between LESS COLD and MORE COLD.

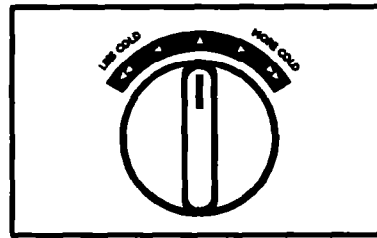

Economy control

The Economy Control operates electric heaters around the door openings. These heaters help keep moisture from forming on the outside of the refrigerator.

- Use the **reduce exterior moisture** setting if moisture forms on cabinet.
- Use the **save power** setting when humidity is low.

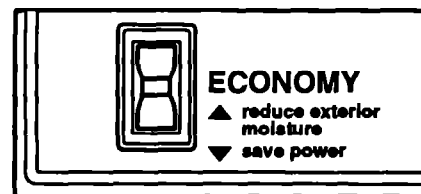

Changing the control settings

If you need to adjust the temperature in either compartment, keep these things in mind:

- Adjusting the Refrigerator Control or the Freezer Control changes the temperature in BOTH compartments.
- Setting the Refrigerator Control to OFF stops cooling in BOTH compartments.

Adjusting the refrigerator shelves

Adjust the shelves to match the way you use your refrigerator.

Model RT18DK

To remove shelves:

1. Remove items from shelf.
2. Tilt shelf up at front.
3. Lift back of shelf.
4. Pull shelf straight out.

To replace shelves:

1. Guide the rear shelf hooks into the slots in the shelf supports on cabinet wall.
2. Tilt shelf up at front until hooks drop into slots. Lower front of shelf to level position.

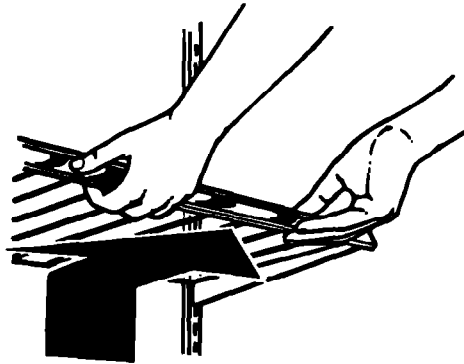

Model RT18EK

To remove the shelves:

1. Remove items from the shelf.
2. Slide shelf straight out to the stop.
3. Lift the front slightly.
4. Slide shelf out the rest of the way.

To replace the shelves:

1. Fit back of shelf between desired pair of shelf guides.
2. Lift the front slightly.
3. Slide shelf in until it clears all stops.
4. Lower shelf to level position.

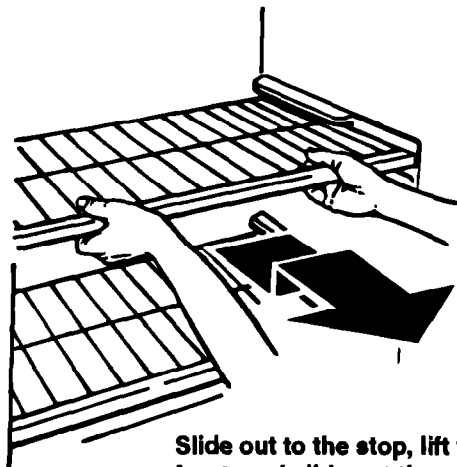

Slide out to the stop, lift the front, and slide out the rest of the way.

Removing the meat drawer and cover

(Model RT18DK only)

Remove the meat drawer and cover for easier cleaning.

To remove the meat drawer:

1. Slide meat drawer out to the stop.
2. Lift the front slightly.
3. Slide meat drawer out the rest of the way.
4. Replace in reverse order.

To remove the cover:

1. Remove the meat drawer.
2. Tilt front of cover up.
3. Pull cover up and out.

To replace the cover:

1. Fit bottom notches of cover over rear and center cross bars of shelf.
2. Lower cover into place.
3. Replace the meat drawer.

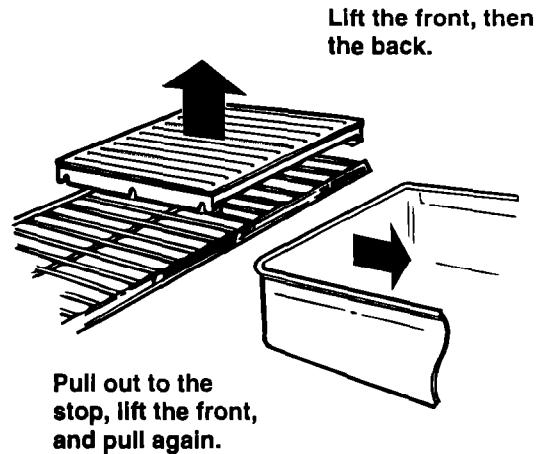

Removing the crispers and crisper cover

(Model RT18DK only)

Use your crispers to store fruit and vegetables.

To remove the crispers:

1. Slide crisper out to the stop.
2. Lift the front.
3. Slide out the rest of the way.
4. Replace in reverse order.

To remove the cover:

1. Lift the front, then the back.
2. Pull cover up and out of cabinet.

To replace the cover:

1. Fit rear cover notches into nubs on rear of refrigerator walls.
2. Lower front of cover into place.

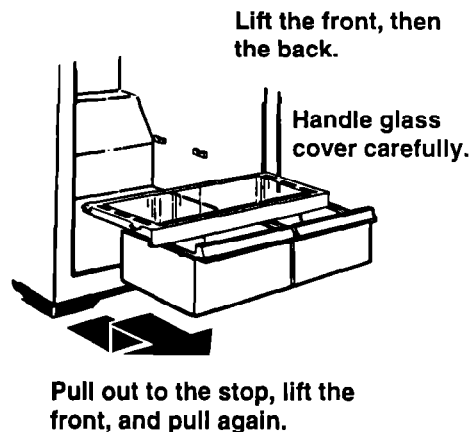

USING YOUR REFRIGERATOR

Using the ice cube trays

If cubes are not used, they may shrink. The moving cold air starts a slow evaporation. The longer you store cubes, the smaller they get.

To remove ice:

1. Hold tray at both ends.
2. Twist slightly.

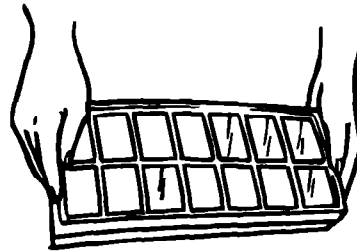

Using the optional automatic ice maker

If your refrigerator has an automatic ice maker, or if you plan to add one later (Kit No. FRKIT94), here are a few things you will want to know.

- The ON/OFF lever is a wire signal arm.

DOWN to make ice automatically
UP to shut off the ice maker

IMPORTANT: Do not turn on the ice maker until it is connected to the water supply. **Instructions for ice maker water supply hookup are attached to the back of the refrigerator cabinet.**

- The dial or lever on the side of the ice maker changes the size of the cubes.
- You may hear water running when the ice maker is working. You'll hear ice falling into the bin. Don't let these sounds bother you.
- If you remove the ice bin, raise the signal arm to shut off the ice maker. When you replace the bin, push it in all the way and lower the ice maker signal arm to the ON position.
- Good water quality is important for good ice quality. Try to avoid connecting the ice maker to a softened water supply. Water softener chemicals (such as salt from a malfunctioning softener) can damage the ice maker mold and lead to poor ice quality. If a softened water supply cannot be avoided, make sure the water softener is operating properly and is well maintained.

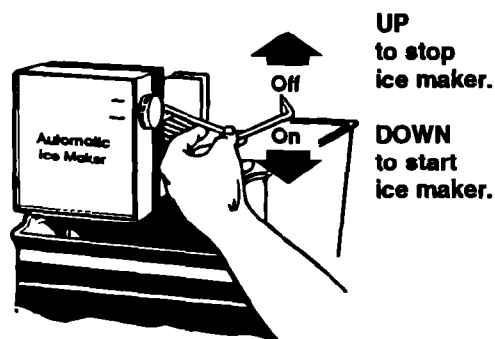

CALL 1-800-447-6737
WITH QUESTIONS OR COMMENTS

Solving common ice maker problems

PROBLEM	POSSIBLE CAUSE/SOLUTION
Ice crescents attached at corners	<ul style="list-style-type: none"> • This is normal. They break apart easily. Shake bin occasionally to keep cubes separated.
Ice maker will not operate or ice is not made fast enough	<ul style="list-style-type: none"> • ON/OFF lever is in the OFF (up) position. Lower lever to the ON (down) position. • Freezer is not cold enough. Adjust temperature controls and wait 24 hours. (See "Changing the control settings" on page 8.)
Off-taste or odor in ice	<ul style="list-style-type: none"> • New plumbing connections can cause discolored or off-flavored ice. Discard the first few batches of ice. • Cubes are stored too long. Throw them away and make a new supply. • Foods in freezer are not wrapped properly. See "Food Storage Guide" on pages 19 and 20. • Freezer and ice bin need to be cleaned. See pages 15 and 16.

Changing the light bulb

⚠ WARNING

Electrical Shock Hazard

Before removing a light bulb, either unplug the refrigerator or disconnect the electricity leading to the refrigerator at the main power supply.

Failure to do so could result in electrical shock or personal injury.

To change the refrigerator light:

1. Disconnect refrigerator from power supply.
2. Reach behind Control Panel to bulb.
3. Replace bulb with a 40-watt appliance bulb.
4. Reconnect refrigerator to power supply.

NOTE: All appliance bulbs will not fit in your refrigerator. Be sure to replace a bulb with one of the same size and shape.

Understanding the sounds you may hear

Your new refrigerator may make sounds that your old one didn't. Because the sounds are new to you, you might be concerned about them. Don't be. Most of the new sounds are normal. Hard surfaces like the floor, walls, and cabinets can make the sounds seem louder.

The following describes the kinds of sounds that might be new to you, and what may be making them.

Slight hum, soft hiss

You may hear the refrigerator's fan motor and moving air.

Clicking or snapping sounds

The thermostat makes a definite click when the refrigerator stops running. It also makes a sound when the refrigerator starts. The defrost timer will click when the defrost cycle starts.

Water sounds

When the refrigerator stops running, you may hear gurgling in the tubing for a few minutes after it stops. You may also hear defrost water running into the defrost water pan.

Ice maker sounds

- trickling water
- thud (clatter of ice)

You may hear buzzing (from the water valve), trickling water, and the clatter of ice dumped into the bin.

Running sounds

Your refrigerator has a high-efficiency compressor and motor. It will run longer than older designs. It may even seem to run most of the time.

Saving energy

You can help your refrigerator use less electricity.

- Check door gaskets for a tight seal. Level the cabinet to be sure of a good seal.
- Clean the condenser coils regularly.
- Open the door as few times as possible. Think about what you need before you open the door. Get everything out at one time. Keep food organized so you won't have to search for what you want. Close door as soon as food is removed.

- Go ahead and fill up the refrigerator, but don't overcrowd it so air movement is blocked.
- It is a waste of electricity to set the refrigerator and freezer to temperatures colder than they need to be. If ice cream is firm in the freezer and drinks are as cold as your family likes them, that's cold enough.
- Make sure your refrigerator is not next to a heat source such as a range, water heater, furnace, radiator, or in direct sunlight.

Reversing the door swing

If you wish to reverse the swing of the doors, follow the steps below.

NOTE: If removing doors to move refrigerator through a doorway, and not reversing the door swing, it may not be necessary to remove the bottom hinge.

TOOLS REQUIRED:

- Phillips™ head screwdriver
- Socket wrench set or adjustable wrench
- Putty knife

To reverse the door swing:

1. Remove the top hinge assembly as shown. Keep all parts together.
After removing top hinge assembly, lift freezer door up off center hinge.

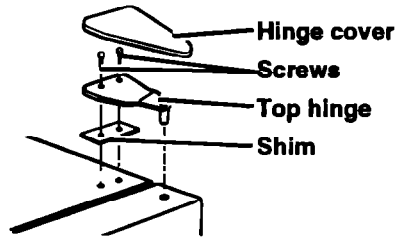

2. Remove the center hinge assembly as shown. Outer most screw is left in place. Remove door stop from bottom of door. Keep all parts together.
After removing the center hinge assembly, lift refrigerator door up off bottom hinge.

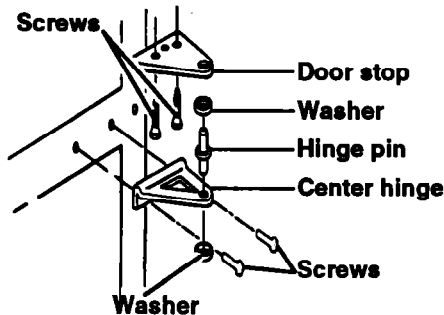

3. Remove the bottom hinge assembly as shown. Remove door stop from bottom of door. Keep all parts together.

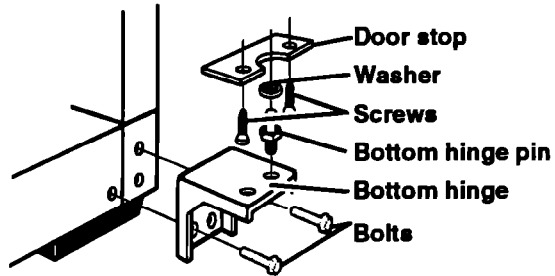

4. Remove cabinet screws from the center hinge holes and reinstall in opposite side holes.

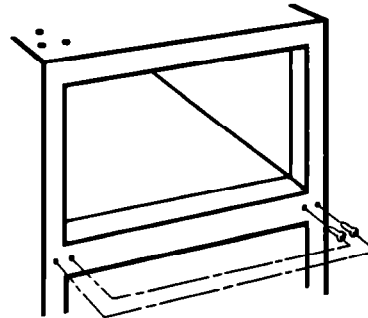

USING YOUR REFRIGERATOR

5. Remove both handle assemblies as shown. Keep all parts together.

Remove hole plugs from opposite side of doors. Reinstall handles on new side. Seal all original holes with hole plugs from new side.

MODEL RT18DK

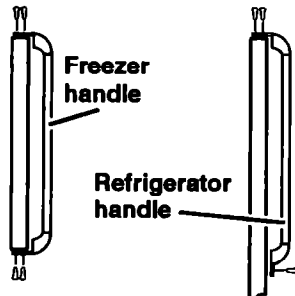

MODEL RT18EK

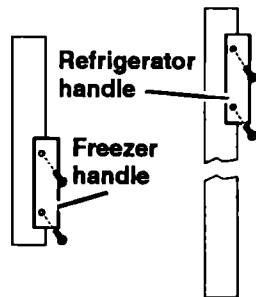

6. Using a putty knife, remove the black plug from the front of the cabinet base (new hinge side) and reinstall it in the old set of lower hinge holes.
7. Reinstall the bottom hinge assembly in the new side. Do not tighten the screws. The hinge must remain loose against the cabinet for easier alignment.
8. Lift the refrigerator door up onto the bottom hinge assembly. Hold door in place while reinstalling center hinge assembly.
9. Level refrigerator door while holding door against front of cabinet. After leveling, tighten bottom and center hinge screws.

10. Remove screws (or plugs) from the hinge holes in the top of the cabinet and reinstall them in the opposite side.

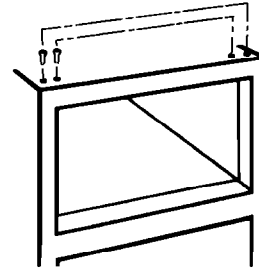

11. Remove plug from upper bearing of freezer door and reinstall on opposite side.

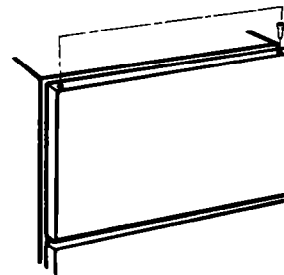

12. Lift freezer door up onto the center hinge assembly. Reinstall top hinge assembly while holding door in place. Do not tighten the screws.
13. Align the doors so they are parallel to each other. Adjust doors to cabinet so the gasket seals but does not bind.
14. Tighten all hinge screws.

Caring for Your Refrigerator

Your refrigerator is built to give you many years of dependable service. However, there are a few things you can do to help extend its product life. This section tells you how to clean your refrigerator and what to do when going on vacation, moving, or during a power outage.

Cleaning your refrigerator



Both the refrigerator and freezer sections defrost automatically. However, clean both about once a month to help prevent odors from building up. Wipe up spills

right away.

To clean your refrigerator, unplug it, take out all removable parts, and clean the refrigerator according to the following directions.

⚠ WARNING

Personal Injury Hazard

Refrigeration system tubes are near the defrost pan and can become hot. Clean defrost pan carefully.

Failure to do so could result in personal injury.

PART	WHAT TO USE	HOW TO CLEAN
Removable parts (shelves, crisper, etc.)	Sponge or cloth with mild detergent and warm water	<ul style="list-style-type: none"> • Hand wash, rinse, and dry thoroughly.
Outside	Sponge, cloth, or paper towel with mild detergent, warm water, and an appliance wax (or good auto paste wax)	<ul style="list-style-type: none"> • Wash outside of cabinet. Do not use abrasive or harsh cleaners. • Wipe and dry thoroughly. • Wax painted metal surfaces at least twice a year. Apply wax with a clean, soft cloth. Waxing painted metal surfaces provides rust protection. • Do not wax plastic parts.
Inside walls (allow freezer to warm up so cloth won't stick)	Sponge, soft cloth, or paper towel with baking soda or mild detergent and warm water	<ul style="list-style-type: none"> • Wash with mixture of warm water and <ul style="list-style-type: none"> – mild detergent, or – baking soda (2 tablespoons [26 g] to 1 quart [.95 L] of water). • Wipe and dry thoroughly.

CARING FOR YOUR REFRIGERATOR

PART	WHAT TO USE	HOW TO CLEAN
Door liners and gaskets	Sponge, soft cloth, or paper towel with mild detergent and warm water	<ul style="list-style-type: none"> • Wash, wipe, and dry thoroughly. DO NOT USE cleaning waxes, concentrated detergents, bleaches, or cleaners containing petroleum on plastic parts.
Plastic parts (covers and panels)	Soft, clean sponge or soft, clean cloth with mild detergent and warm water	<ul style="list-style-type: none"> • Wash, rinse or wipe, and dry thoroughly. DO NOT USE paper towels, window sprays, scouring cleansers, or flammable fluids. These can scratch or damage material. See "Important Safety Instructions" on page 3.
Defrost pan (behind refrigerator on top of compressor)	Sponge or cloth with mild detergent and warm water	<ul style="list-style-type: none"> • Roll refrigerator out away from the wall. • Wash defrost pan. Do not remove defrost pan to clean. • Wipe and dry thoroughly. • Roll refrigerator back into place. • Level refrigerator.
Condenser coils (on back of cabinet)	Vacuum cleaner with extended narrow attachment	<ul style="list-style-type: none"> • Roll refrigerator out away from the wall. • Vacuum coils at least once every other month. • Roll refrigerator back into place. • Level refrigerator.
Floor under refrigerator	Floor cleaners	<ul style="list-style-type: none"> • Roll refrigerator out only as far as the water supply line allows. • Clean floor. • Roll refrigerator back into place. • Check to see if the refrigerator is level.

Vacation and moving care

Long vacations

If you will be gone a month or more:

1. Remove all food from the refrigerator.
2. If your refrigerator has an automatic ice maker:
 - Turn off the water supply to the ice maker at least one day ahead of time.
 - When the last load of ice drops, turn off the ice maker. Make sure all ice is dispensed out of the ice maker mechanism.
3. Unplug the refrigerator.
4. Clean it, rinse well, and dry.
5. Tape rubber or wood blocks to the tops of both doors to prop them open far enough for air to get in. This stops odor and mold from building up.

⚠ WARNING

Personal Injury Hazard

Do not allow children to climb on, play near, or climb inside the refrigerator when the doors are blocked open. They may become injured or trapped.

To restart refrigerator, see "Using Your Refrigerator" on page 7.

Short vacations

No need to shut off the refrigerator if you will be away for less than four weeks.

1. Use up any perishables.
2. Freeze other items.
3. If your refrigerator has an automatic ice maker:
 - Raise the signal arm to the OFF (up) position.
 - Shut off the water supply to the ice maker.
 - Empty the ice bin.

Moving

When you are moving the refrigerator to a new home:

1. If your refrigerator has an automatic ice maker:
 - Turn off the water supply to the ice maker at least one day ahead of time.
 - Disconnect the water line.
 - After the last load of ice drops, lift the signal arm to the OFF (up) position.
2. Remove all food from the refrigerator.
3. Pack all frozen food in dry ice.
4. Unplug the refrigerator.
5. Clean it thoroughly. Rinse well and dry.
6. Take out all removable parts, wrap them well, and tape them together so they don't shift and rattle.
7. Screw in the leveling rollers.
8. Tape the doors shut and tape the power supply cord to the cabinet.

When you get to your new home, put everything back and refer to page 5. Also, if your refrigerator has an automatic ice maker, remember to reconnect the water supply line.

Power interruptions

If electricity goes off, call the power company. Ask how long power will be off.

1. If service will be interrupted 24 hours or less, **keep both doors closed**. This helps foods stay frozen.
2. If service will be interrupted longer than 24 hours:
 - (a) Remove all frozen food and store in a frozen food locker.

OR

 - (b) Place 2 lbs. (0.9 kg) of dry ice in freezer for every cubic foot of freezer space. This will keep food frozen for 2 to 4 days. Wear gloves to protect your hands from dry ice burns.

OR

 - (c) If neither a food locker or dry ice is available, use or can perishable food at once.

3. A full freezer stays cold longer than a partly filled one. A freezer full of meat stays cold longer than a freezer full of baked goods. If food contains ice crystals, it may be safely refrozen, although the quality and flavor may be affected. If the condition of the food is poor, or if you feel it is unsafe, dispose of it.

Questions ?

Call our toll-free number, 1-800-44-ROPER.

Food Storage Guide

There is a correct way to package and store refrigerated or frozen food. To keep food fresher, longer, take the time to study these recommended steps.

Storing fresh food

Wrap or store food in the refrigerator in airtight and moisture-proof material. This prevents food odor and taste transfer throughout the refrigerator. For dated products, check code date to ensure freshness.

Leafy vegetables

Remove store wrapping and trim or tear off bruised and discolored areas. Wash in cold water and drain. Place in plastic bag or plastic container and store in crisper.

Vegetables with skins (carrots, peppers)

Store in crisper, plastic bags, or plastic container.

Fruit

Wash, let dry, and store in refrigerator in plastic bags or crisper. Do not wash or hull berries until they are ready to use. Sort and keep berries in their original container in a crisper, or store in a loosely closed paper bag on a refrigerator shelf.

Eggs

Store without washing in the original carton on interior shelf.

Milk

Wipe milk cartons. For best storage, place milk on interior shelf.

Butter or margarine

Keep opened butter in covered dish or closed compartment. When storing an extra supply, wrap in freezer packaging and freeze.

Cheese

Store in the original wrapping until you are ready to use it. Once opened, rewrap tightly in plastic wrap or aluminum foil.

Leftovers

Cover leftovers with plastic wrap or aluminum foil. Plastic containers with tight lids can also be used.

Meat

Store most meat in original wrapping as long as it is airtight and moisture-proof. Rewrap if necessary. See the following chart for storage times.

TYPE	APPROXIMATE TIME (DAYS)*
Chicken	1 to 2
Ground beef	1 to 2
Steaks and roasts	3 to 5
Cured meats	7 to 10
Bacon	5 to 7
Cold cuts	3 to 5
Variety meats	1 to 2

* When storing meat longer than the times given, follow the directions for freezing.

NOTE: Use fresh fish and shellfish the same day as purchased.

Storing frozen food

The freezer section is designed for storage of commercially frozen food and for freezing food at home.

NOTE: For further information about preparing food for freezing or food storage times, contact your local Cooperative Extension Service or check a freezer guide or reliable cookbook.

Packaging

The secret of successful freezing is in the packaging. The way you close and seal the package must not allow air or moisture in or out. Packaging done in any other way could cause food odor and taste transfer throughout the refrigerator and drying of frozen food.

Packaging recommended for use:

- Rigid plastic containers with tight-fitting lids
- Straight-sided canning/freezing jars
- Heavy-duty aluminum foil
- Plastic-coated paper
- Non-permeable plastic wraps (made from a saran film)

Follow package or container instructions for proper freezing methods.

Do not use:

- Bread wrappers
- Non-polyethylene plastic containers
- Containers without tight lids
- Wax paper
- Wax-coated freezer wrap
- Thin, semi-permeable wrap

The use of these wrappings could cause food odor, taste transfer, and drying of frozen food.

Freezing

Do not expect your freezer to quick-freeze any large quantity of food. Put no more unfrozen food into the freezer than will freeze within 24 hours (no more than 2 to 3 pounds of food per cubic foot of freezer space). Leave enough space for air to circulate around packages. Be careful to leave enough room at the front so the door can close tightly.

Storage times will vary according to the quality of the food, the type of packaging or wrap used (airtight and moisture-proof), and the storage temperature, which should be 0°F (-17.8°C).

Troubleshooting

Listed in the chart below are the most common problems consumers run into with their refrigerator. Please read through this chart before calling for service. It could save you the cost of a service call.

PROBLEM	CHECK THE FOLLOWING
Your refrigerator will not operate	<p>Is the power supply cord firmly plugged into a live circuit with proper voltage?</p> <p>Has a household fuse or circuit breaker blown/tripped?</p> <p>Is the Refrigerator Control set to the OFF position?</p>
The lights do not work	<p>Is the power supply cord firmly plugged into a live circuit with proper voltage?</p> <p>Has a household fuse or circuit breaker blown/tripped?</p> <p>Is a bulb burned out?</p>
The optional ice maker does not work	<p>Is the freezer cold enough to make ice? It could take overnight for the freezer to reach the proper temperature.</p> <p>Is the ON/OFF lever in the ON (down) position? (See page 10.)</p> <p>Is the water valve turned on?</p> <p>Does the water line have a clog or leak?</p>
You hear unfamiliar sounds or a rattling/jingling noise	<p>Is something on top of or behind the refrigerator?</p> <p>Some new sounds are normal. See "Understanding the sounds you may hear" on page 12.</p>
There is water in the defrost pan	<p>This is normal on hot, muggy days. Make sure the refrigerator is level so the pan does not overflow.</p>
The motor seems to run too much	<p>Are the condenser coils dirty?</p> <p>Has the door been opened often? Has a large amount of food been added at one time? The motor naturally runs longer if these things happen.</p> <p>Is the room hot? If the room is too warm, the motor runs longer to keep the unit cool.</p>

Requesting Assistance or Service

Before calling for assistance or service, please check "Troubleshooting" on page 21. It may save you the cost of a service call. If you still need help, follow the instructions below.

1. If you need assistance* ...



Call our toll-free telephone number. Dial free from anywhere in the U.S.A.:
1-800-44-ROPER
(1-800-447-6737)

and talk with one of our trained consultants. The consultant can instruct you in how to obtain satisfactory operation from your appliance or, if service is necessary, recommend a qualified service company in your area.

If you prefer, write to:

Mr. William Clark
Consumer Assistance Representative
Whirlpool Corporation
2000 N State Route 63
Benton Harbor, MI 49022-2692

Please include a daytime phone number in your correspondence.

2. If you need service* ...



Contact the dealer from whom you purchased the appliance or the authorized servicer in your area. For help finding an authorized servicer in your area, call our toll-free number in Step 1.

3. If you need FSP® replacement parts ...

FSP is a registered trademark of Whirlpool Corporation for quality parts. Look for this symbol of quality whenever you need a replacement part for your Roper® appliance. FSP replacement parts will fit right and work right, because they are made to the same exacting specifications used to build every new Roper appliance.

To locate FSP replacement parts in your area, refer to Step 2 or call our toll-free telephone number in Step 1.

4. If you are not satisfied with how the problem was solved ...

- Contact the Major Appliance Consumer Action Panel (MACAP). MACAP is a group of independent consumer experts that voices consumer views at the highest levels of the major appliance industry.
- Contact MACAP only when the dealer, authorized servicer, and Whirlpool have failed to resolve your problem.

Major Appliance Consumer Action Panel
20 North Wacker Drive
Chicago, IL 60606

- MACAP will in turn inform us of your action.

*When asking for help or service:

Please provide a detailed description of the problem, your appliance's complete model and serial numbers, and the purchase date. (See page 2.) This information will help us respond properly to your request.

Index

This index is alphabetical. Look for the word or phrase you are interested in, then look for the page number.

<u>TOPIC</u>	<u>PAGE</u>	<u>TOPIC</u>	<u>PAGE</u>
CARE		LIGHT BULB	
Moving	17	Changing	11
Power interruptions	18		
Vacation	17	PARTS/FEATURES	4
		RESPONSIBILITIES	
CLEANING	5, 15-16	Owner	3
CONTROLS		SAFETY	3
Changing settings	8		
Setting	7	SERVICE	
		Parts	22
CRISPERS		Requesting	22
Cover	9		
Removing	9	SHELVES	
		Refrigerator, removing	8
ELECTRICAL NEEDS	5		
		SOUNDS	
FEATURES/PARTS	4	Normal	12
FOOD STORAGE		TROUBLESHOOTING	21
Fresh	19		
Frozen	20	WARRANTY	24
ICE MAKER			
Common problems	11		
Using	10		

ROPER®

Refrigerator Warranty

LENGTH OF WARRANTY	WE WILL PAY FOR
FULL ONE-YEAR WARRANTY (from date of purchase)	FSP® replacement parts and repair labor to correct defects in materials or workmanship. Service must be provided by an authorized Roper service company.
FULL FIVE-YEAR WARRANTY (from date of purchase)	FSP replacement parts and repair labor for the sealed refrigeration system (compressor, evaporator, condenser, drier, or connecting tubing) which we find to be defective in materials or workmanship. Service must be provided by an authorized Roper service company.
WE WILL NOT PAY FOR	
<p>A. Service calls to:</p> <ol style="list-style-type: none"> 1. Correct the installation of your refrigerator. 2. Instruct you how to use your refrigerator. 3. Replace house fuses or correct house wiring or plumbing. 4. Replace light bulbs. <p>B. Repairs when your refrigerator is used in other than normal, single-family household use.</p> <p>C. Pickup and delivery. Your refrigerator is designed to be repaired in the home.</p> <p>D. Damage to your refrigerator caused by accident, misuse, fire, flood, acts of God, or use of products not approved by Whirlpool.</p> <p>E. Repairs to parts or systems caused by unauthorized modifications made to the appliance.</p>	

5/93

This Roper appliance is warranted by Whirlpool Corporation. Under no circumstances shall it be liable under this warranty for incidental or consequential damages and all implied warranties are limited to the same time period stated in the express warranties for Roper Brand Appliances. Some states do not allow the exclusion or limitation of incidental or consequential damages, or limitation of implied warranties, so these exclusions or limitations may not apply to you.

This warranty gives you specific legal rights, and you may have other rights which vary from state to state.

Outside the United States, a different warranty may apply. For details, please contact your authorized Roper distributor or military exchange.

If you need service, first see the "Requesting Assistance or Service" section of this book. After checking "Requesting Assistance or Service," additional help can be found by calling our toll-free telephone number, 1-800-44-ROPER (1-800-447-6737), from anywhere in the U.S.A.



Printed on recycled paper –
 10% post-consumer waste
 50% recovered materials

PART NO. 218504800/4343263

© 1995 Whirlpool Corporation

® Registered Trademark / SM Service Mark of Whirlpool, U.S.A.

Printed in U.S.A.